

Starter Motors

Validated

to exceed 40,000 cycle starts

Replacement for:

Delco Remy 50MT™

Leece Neville Titan™ 125 Series & MS7 Series

Applications:

HD Trucks, Industrial, Agricultural



207-25201

24V, 9.0kW, CW, 11T

207-25202

24V, 9.0kW, CW, 12T

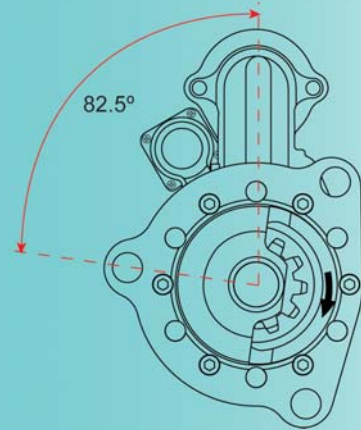

FEATURES

- Replacement for Delco Remy 50MT
- 9.0 kW of power
- Planetary Gear Reduction
- Integral Magnetic Switch
- Rotatable D.E. Housing
- Lightweight of 42 Lbs / 19 Kg.
- Integrated Over Crank Protection
- Soft Start Engagement

PERFORMANCE CURVES
24V, 9.0 kW

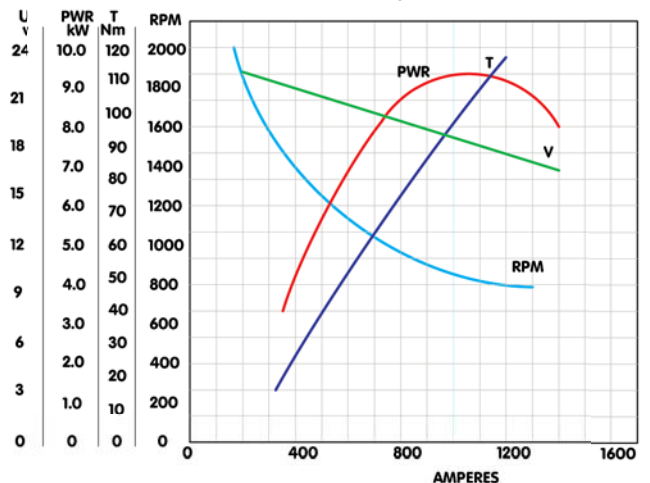

207-25201
24V, 9.0kW, CW, 11T
42 Lbs. / 19 Kg.



207-25202
24V, 9.0kW, CW, 12T
42 Lbs. / 19 Kg.



REPLACES



Delco Remy 50MT™
78 Lbs. / 36 Kg.

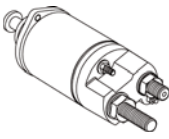
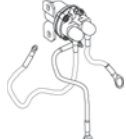

Leece Neville MS7
61 Lbs. / 28 Kg.

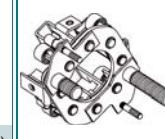
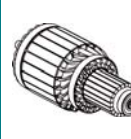
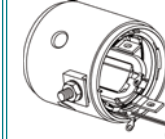
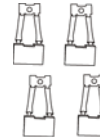
SOLENOID ASSY.	RELAY SWITCH	DRIVE ASSY.	BRUSH HOLDER ASSY.	ARMATURE	FIELD CASE ASSY.	BRUSHES SET
						
6607-2521	6707-2520	5407-2501 (11T) 5407-2502 (12T)	6907-2501	6107-2521	5707-2521	68007-250K

REFERENCE NUMBERS*				
CASE	CUMMINS	DELCO REMY	DELCO REMY	FORD
462588C91	3603868RX	1109840	1993989	E2HT-11001-CA
489717C91		1109841	1993841	
739912C91	DELCO REMY	1990229	10461125	INTERNATIONAL
	1109288	1990231	10461739	489717C91
CATERPILLAR	1109289	1990235	10479323	729912C91
5L3648	1109290	1990259	10479339	844317C91
6N9667	1109291	1990260		
6T0640	1109647	1990262	FIAT ALLIS	LEECE NEVILLE/
6V0511	1109649	1990263	70675686	PRESTOLITE
	1109772	1990270	73114229	M125701
CUMMINS	1109773	1990271	73130198	M125703
3021038	1109774	1990272		M125R3001SEP
3063771	1109775	1993739	FORD	M125R3003SEP
3632274	1109776	1993840	D7HT-11001-AA	
	1109839	1993847	E1HT-11001-DB	

*For additional cross reference information & updates, visit our website e-Cat: www.dixie-electric.com

CANADA & EXPORT SALES

Dixie Electric Ltd. Tel.: 905-879-0533 800-461-5799
517 Basaltic Road Fax: 905-879-0532
Concord, ON. E-Mail: sales@dixie-electric.com
Canada L4K 4W8 Web Site: www.dixie-electric.com



U.S.A. SALES

Dixie Electric Inc. Tel.: 763-475-6629 800-478-0608
17100 Medina Rd, Suite 100 Fax: 763-475-6635 800-392-8719
Minneapolis, MN. E-Mail: mn.sales@dixie-electric.com
U.S.A. 55447-1249 Web Site: www.dixie-electric.com